









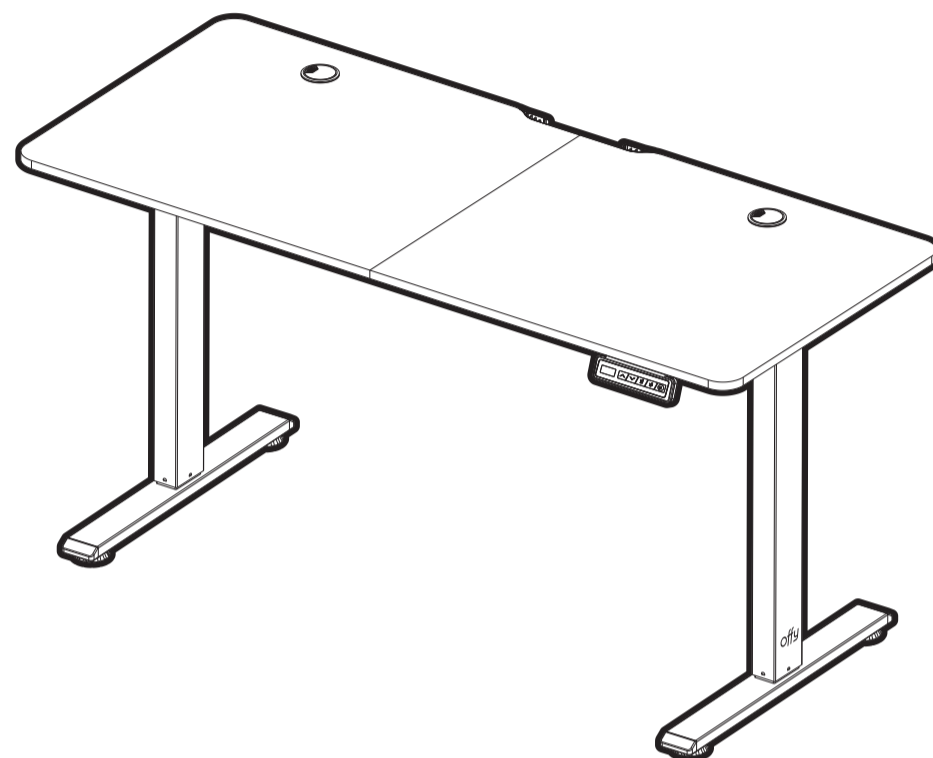

RYVA

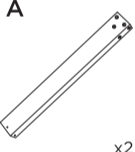
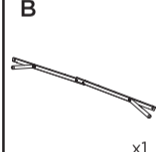
ASSEMBLY GUIDE
GUIA DE MONTAGEM

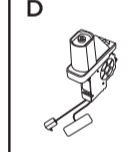
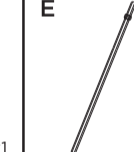
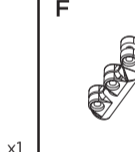
offy

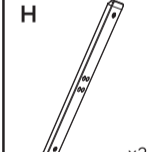
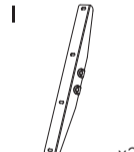
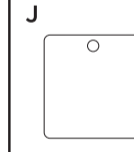
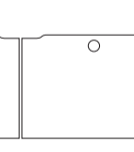
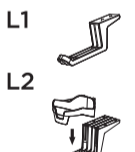
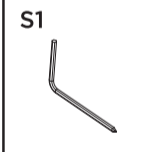
www.offy.pt

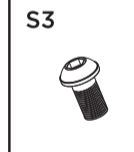
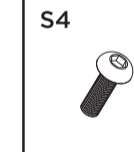
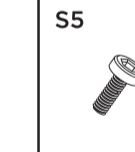
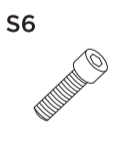
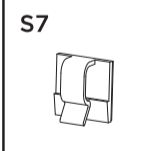

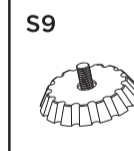
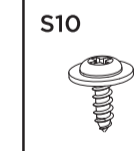
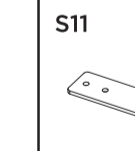
A  x2	B  x1	C  x1	D  x1	E  x1	F  x1
G  x1	H  x2	I  x2	J  x1	K  x1	
L1  x1	S1  6mm x1	S2  3mm x1	S3  M8*16 x15	S4  M5*16 x2	S5  M4*12 x2
S6  M8*25 x8	S7  x3	S8  x2	S9  x4	S10  M4*14 x36	S11  x2

PT

Quando a secretária é instalada pela primeira vez (ou quando ocorre um erro) deverá proceder do seguinte modo:

- Desligue o cabo de alimentação e a linha do motor e volte a ligar confirmando que as conexões ficam bem encaixadas
- Faça uma redefinição (RESET): Pressione o botão de Reset durante 3 segundos até o ecrã mostrar "-- --" e solte o botão. A secretária sobe até à altura máxima e desce até à altura mínima, até parar indicando que o processo está completo.

Assegure-se que a secretária não encontra obstáculos ao fazer o movimento de subida/descida de modo a proteger bens e pessoas.

EN

When the desk is installed for the first time (or when an error occurs) you should proceed as follows:

- Disconnect the power cable and motor line and reconnect, making sure the connections are securely fitted.
- Perform a reset (RESET): Press the Reset button for 3 seconds until the screen shows "-- --" and release the button. The desk rises to the maximum height and lowers to the minimum height, until it stops indicating that the process is complete.

Make sure that the desk does not encounter obstacles when moving up/down in order to protect property and people.

PT

ASSISTÊNCIA TÉCNICA

Para questões de ordem técnica, por favor visite www.offy.pt ou contacte-nos através de support@offy.pt.

DECLARAÇÃO DE CONFORMIDADE COM DIRECTIVAS DA UNIÃO EUROPEIA

A Offy declara que este produto está em conformidade com os requisitos essenciais e outras disposições relevantes das Directivas 2014/30/EU; 2014/35/EU; 2011/65/EU, conforme aplicável. A documentação técnica exigida pelo processo de Avaliação de Conformidade encontra-se na posse da Offy e poderá ser solicitada através de support@offy.pt.

ELIMINAÇÃO DE RESÍDUOS DE PILHAS E DE EQUIPAMENTO ELÉCTRICO E ELECTRÓNICO

A existência deste símbolo no produto, nas pilhas ou nas respectivas embalagens significa que este produto e as pilhas nele contidas não podem ser eliminados juntamente com os resíduos domésticos. É da responsabilidade do utilizador entregar este produto num ponto de recolha aplicável à reciclagem de pilhas e de equipamento eléctrico e electrónico. Esta recolha e reciclagem separada contribui para a conservação dos recursos naturais e suprime potenciais consequências negativas para a saúde humana e para o ambiente resultantes de uma eliminação inadequada de substâncias perigosas existentes nas pilhas e no equipamento eléctrico e electrónico. Para mais informações sobre os pontos de recolha de pilhas e resíduos eléctricos e electrónicos contacte os serviços municipais locais.

EN

TECHNICAL ASSISTANCE

Regarding technical issues, please visit www.offy.pt or contact us through support@offy.pt.

STATEMENT OF COMPLIANCE WITH EUROPEAN UNION DIRECTIVES

Offy declares that this product is in compliance with the essential requirements and other relevant provisions from the following Directives: 2014/30/EU; 2014/35/EU; 2011/65/EU, as applicable. The technical documentation required by the Conformity Evaluation process is in Offy's possession and can be requested through support@offy.pt.

DISPOSAL OF BATTERIES AND ELECTRICAL OR ELECTRONIC EQUIPMENT WASTE

The existence of this symbol on the product, batteries or respective packaging, signifies that this product and the contained batteries can not be disposed as domestic waste. It is the user's responsibility to deliver this product at a batteries, electrical or electronic recycling pick-up point. The pick-up and separate recycling contributes for the preservation of natural resources and suppresses potential negative consequences for the human health and the environment resultant of inadequate disposal of dangerous substances contained in batteries and electrical or electronic equipment. For additional informations regarding batteries, electrical or electronic recycling pick-up points, please contact your local municipal services.



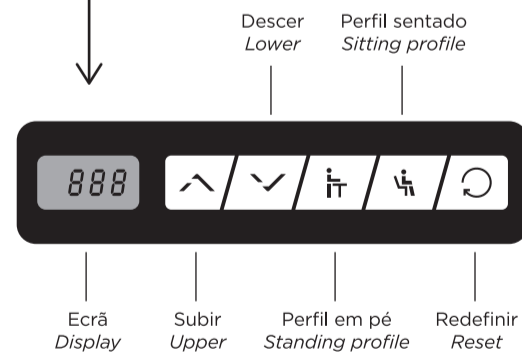
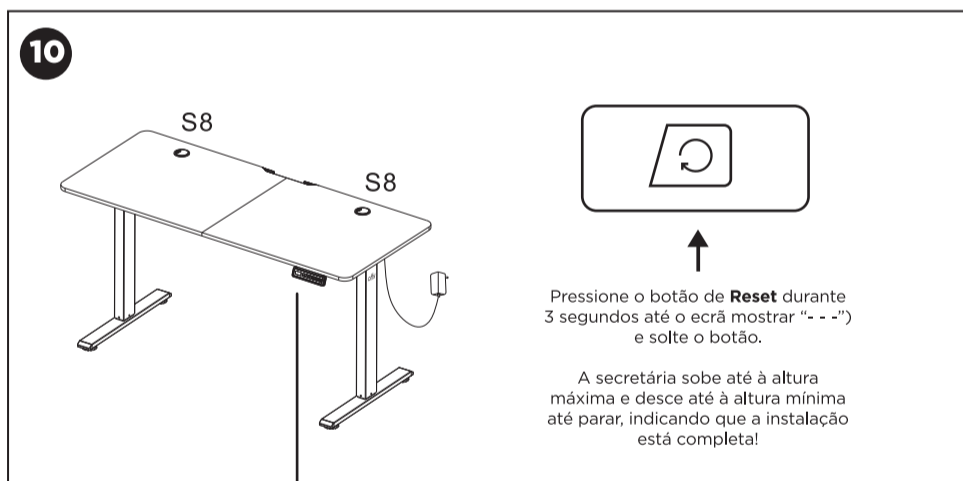
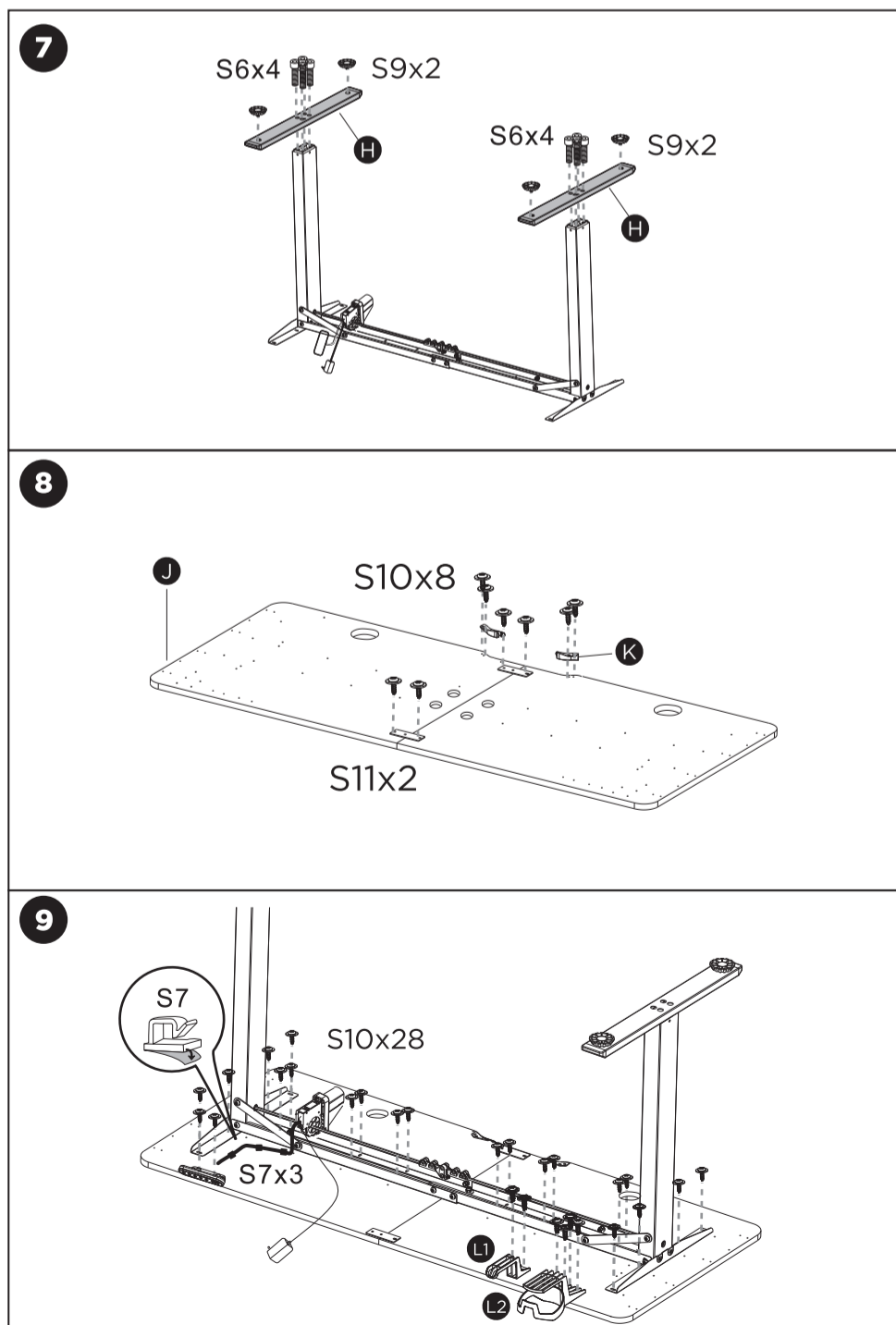
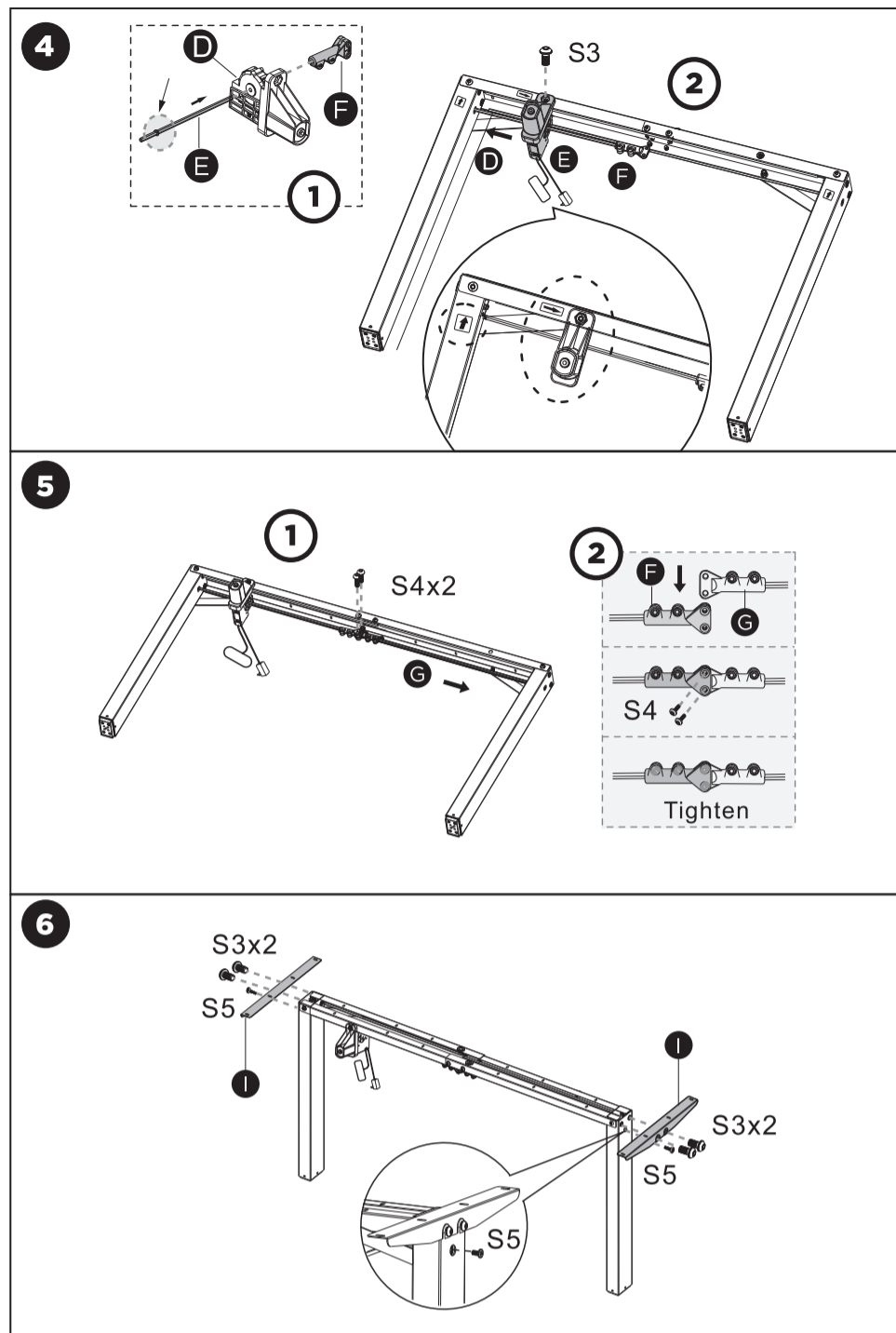
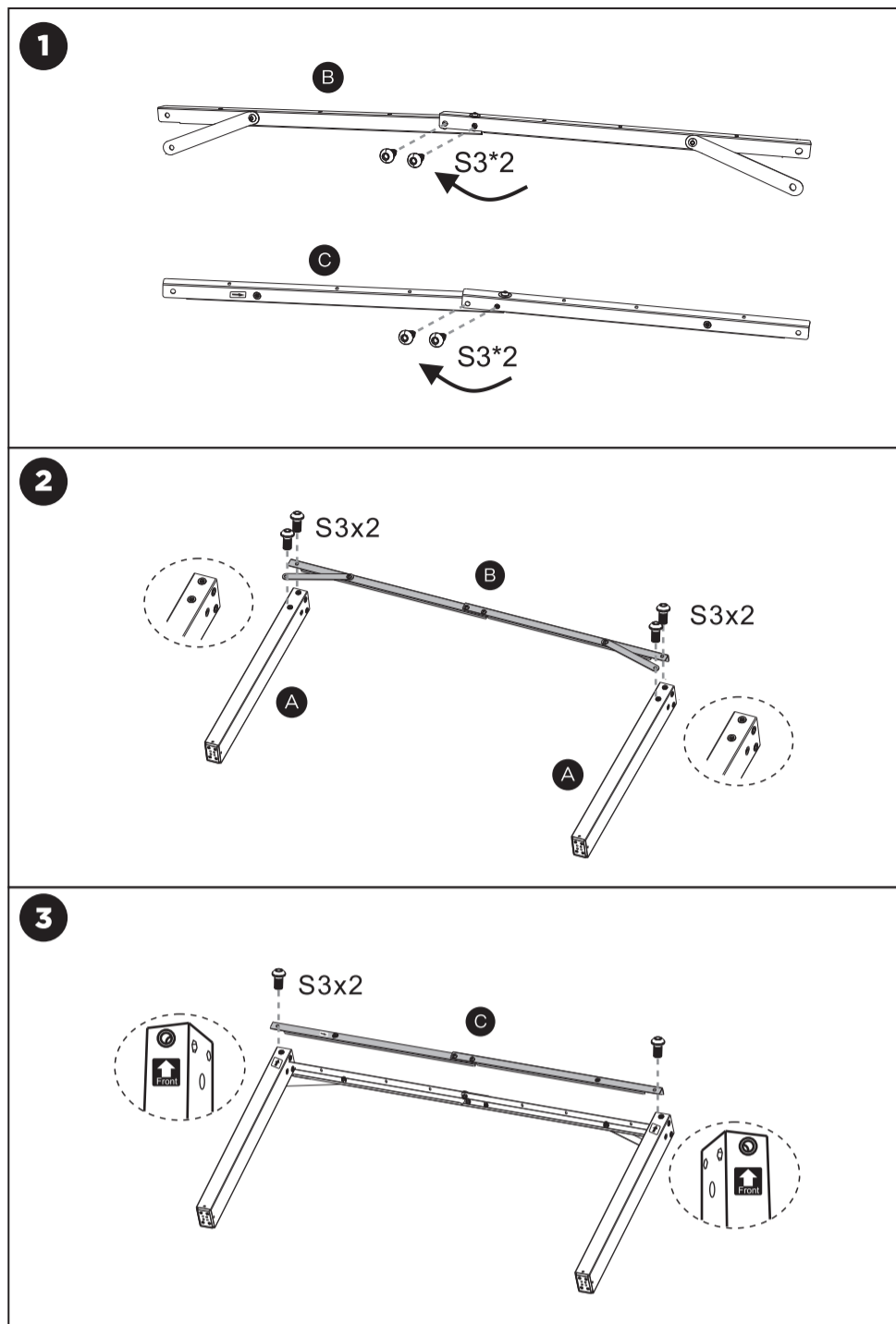

PT

Subir

Pressione para subir a secretária. Pressione durante 3 segundos para subir automaticamente até à altura máxima.

Descer

Pressione para descer a secretária. Pressione durante 3 segundos para descer automaticamente até à altura mínima.

Perfil em pé

Pressione para seleccionar o perfil "em pé". Pressione durante 3 segundos para guardar a altura atual na memória do perfil "em pé".

Perfil sentado

Pressione para seleccionar o perfil "sentado". Pressione durante 3 segundos para guardar a altura atual na memória do perfil "sentado".

EN

Raise

Press to raise the desk. Press for 3 seconds to automatically rise to maximum height.

Lower

Press to lower the desk. Press for 3 seconds to automatically lower to the minimum height.

Standing profile

Press to select the "standing" profile. Press for 3 seconds to save the current height in the "standing" profile memory.

Sitting profile

Press to select the "sitting" profile. Press for 3 seconds to save the current height in the "sitting" profile memory.